



# INSTRUCTION MANUAL



**THE HUBSAN X4** No. H107  
2.4GHZ RC SERIES 4 CHANNEL FLYING INDOOR AND OUTDOOR

*Flip tips kindly check page 14-15*



## H107 Spare Part Chart



**H107-A01**  
Body Shell



**H107-A02**  
Blades

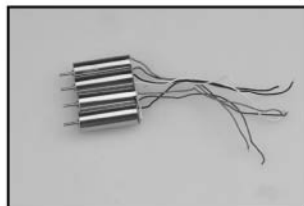

**H107-A03**  
Motor

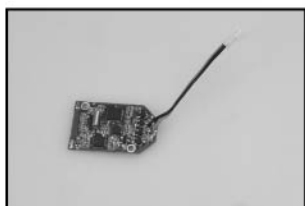

**H107-A04**  
X4 RX

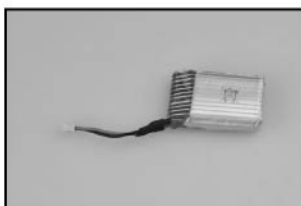

**H107-A05**  
Battery



**H107-A06**  
USB Charger



**H107-A07**  
Screw Set



**H203-16**  
Transmitter

## 1 INTRODUCTION

Thank you for buying HUBSAN products. The quadcopter is designed as an easy to use, full featured RC model capable of all forms of rotary flight. Please read the manual carefully and follow all precautions and recommendations within the manual. Be sure to retain the manual for future reference, routine maintenance, and tuning.

### 1.1 IMPORTANT NOTES

This RC quadcopter is not a toy, it utilizes various high-tech products and technologies to provide superior performance.

Please read this manual carefully before operating this product. Improper use of this product can result in serious injury. Be aware of your personal safety, safety of others and your surrounding environment.

We recommend that you obtain the assistance of an experienced pilot before attempting to fly our product for the first time.

## 2 SAFETY NOTES

### 2.1 CAUTION

R/C quadcopter have parts that move at high speed, thus posing a certain degree of danger. Pilots are responsible for any actions resulting in damage or injury from the improper operation of their R/C aircraft models.

Choose a wide open space without obstacles. Do not operate R/C aircraft near buildings, crowds of people, high voltage cables, or trees to ensure the safety of yourself, others and your model.

Operate this unit within your ability. Do not fly whilst tired, improper operation may cause in danger.

### 2.2 LiPo Battery Recharging

Your quadcopter is powered by a Lithium-Polymer (LiPo) battery.

Never recharge your battery whilst it is inserted in your model. It can catch fire leading to the total destruction of the item.



## SAFETY ADVISORY NOTICE

[ Lithium-Polymer (LiPo) Batteries ]



LiPo batteries differ from conventional batteries in that their chemical contents are encased in a relatively insubstantial foil packaging. This has the advantage of significantly reducing their weight, but does make them more susceptible to damage if roughly or inappropriately handled. As with all batteries, there is a risk of fire or explosion if safety practices are ignored:

- ☑ **Charge and store LiPo batteries in a location where a battery fire or explosion (including smoke hazard) will not endanger life or property**
- ☑ Keep LiPo batteries away from children and animals
- ☑ Consider how you would deal with a LiPo battery fire/explosion as part of your normal home Fire Safety & Evacuation Planning
- ☑ Never charge a LiPo pack that has ballooned or swelled due to over-/under-charging or from a crash
- ☑ Never charge a LiPo battery pack that has been punctured or damaged in a crash (After a crash, inspect the battery pack for the sign of damage. Discard in accordance with your country's recycling laws.)
- ☑ Do not charge LiPo batteries near flammable materials or liquids
- ☑ Ensure that charging leads are connected correctly. Reverse polarity charging can lead to battery damage or a fire or explosion
- ☑ Never charge a LiPo battery in a moving vehicle
- ☑ Only charge your LiPo battery using the supplied "balanced" charger
- ☑ Have a suitable (electrical type) fire extinguisher near the charging area OR a large bucket of dry sand. Do not try to extinguish electrical (LiPo) battery fires with water
- ☑ Reduce risks from fire/explosion by storing and charging LiPo batteries inside a suitable container: a LiPo Sack or metal/ceramic container is advised
- ☑ Monitor recharging LiPo batteries for signs of overheating
- ☑ Never over charge a LiPo battery
- ☑ Never leave a LiPo battery unattended during recharging
- ☑ Protect your LiPo battery from accidental damage during storage and transportation. (Do not put battery packs in pockets or bags where they can short circuit or can come into contact with sharp or metallic objects.)
- ☑ If your LiPo battery is subjected to a shock (such as a helicopter crash) you should place it in a metal container and observe for signs of swelling or heating for at least 30 minutes
- ☑ Do not attempt to disassemble or modify or repair a LiPo battery

### 6.3.3 Forward somersault

Push the joystick to the back and then quickly push the joystick from the back to the front

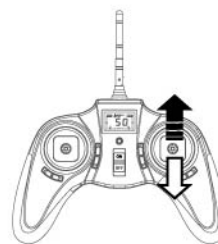

MODE 2

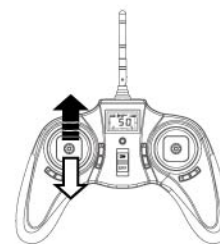

MODE 1

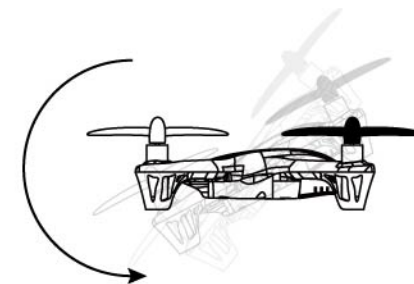

### 6.3.4 Backward somersault

Push the joystick to the front and then quickly push the joystick from the front to the back



MODE 2

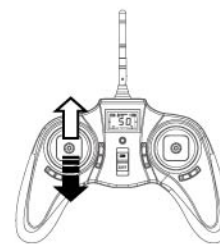

MODE 1

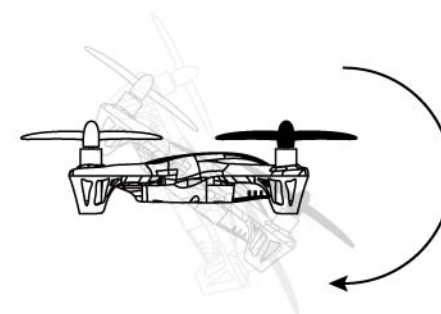



### 6.3 Aerial Somersault Tips.



Your quadcopter can do 360° evertion by pushing the joystick quickly on the condition that the flight surface forming a 30° angle with the ground and the quadcopter in the acceleration period from the low height to high height.

#### 6.3.1 Left side somersault

Push the joystick to the right side and then quickly push the joystick from the right to the left.

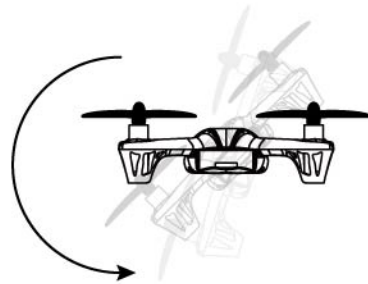
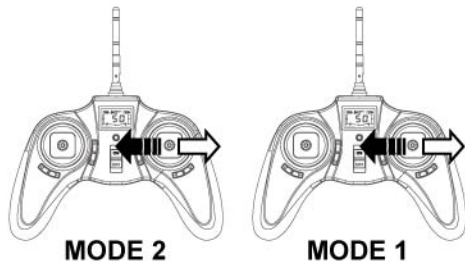

#### 6.3.2 Right side somersault

Push the joystick to the left side and then quickly push the joystick from the left to the right.

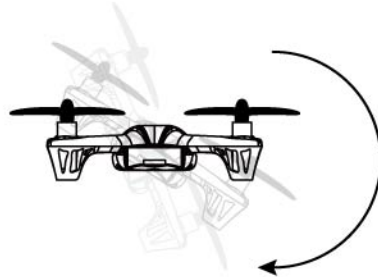
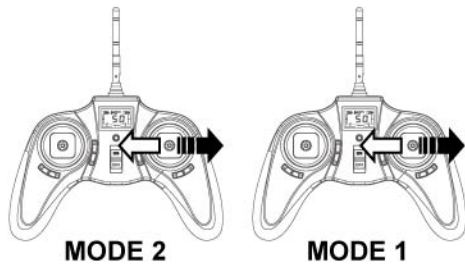

### 2.3 PREVENT MOISTURE

R/C models are composed of many precision electrical components. It is critical to keep the model and associated equipment away from condensation and other contaminants. Exposure to water or moisture may cause the model to malfunction resulting in loss of responsiveness, or a crash.

### 2.4 PROPER OPERATION

For the safety purpose, please only use hubsan's spare parts for replacement.

### 2.5 ALWAYS BE AWARE OF THE ROTATING BLADES

When in operation, the main and tail rotor blades will be spinning at high speed. The blades are capable of inflicting serious body injury and damage to the environment. Be cautious of your actions and careful to keep your body and loose clothing away from the blades. Never take your eyes off the model or leave it unattended while it is turned on. Once landed, immediately turn off the model and transmitter.

### 2.6 AVOID FLYING ALONE

Beginners should avoid flying alone whilst learning flight skills. It is advised that an experienced pilot be on hand for guidance.

## 3 SAFETY CHECK BEFORE FLYING

### CAREFULLY INSPECT BEFORE REAL FLIGHT

- Before operation, please check the batteries of the transmitter and receiver are charged enough for the flight.
- Before turning on the transmitter, please check that the throttle stick is in the minimum position.
- Carefully check rotor blades and rotor holders. Broken or premature failure of parts will result in a dangerous situation.
- Check the battery and power plug are securely fastened. Vibration and violent flight may cause the plug to loosen resulting in loss of control.
- When turning on the unit, please follow the power on/off procedure: for Power ON- please turn on the transmitter first, and then turn on the receiver. For Power OFF- please turn off the receiver first and then turn off the transmitter. Improper procedure may cause loss of control of the quadcopter .

# 4 TRANSMITTER

## 4.1 Identification and functional keys

### Main Menu

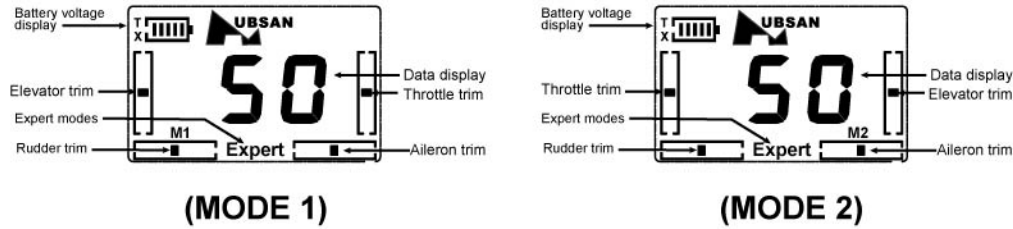

### TRANSMITTER

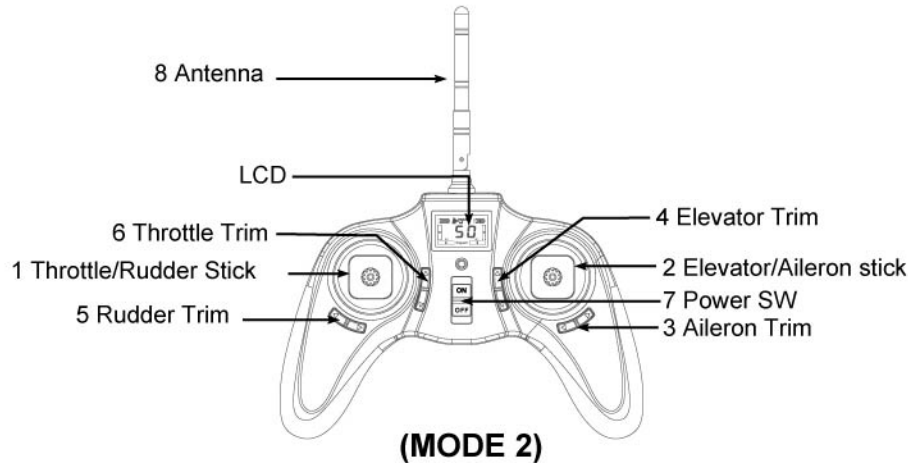
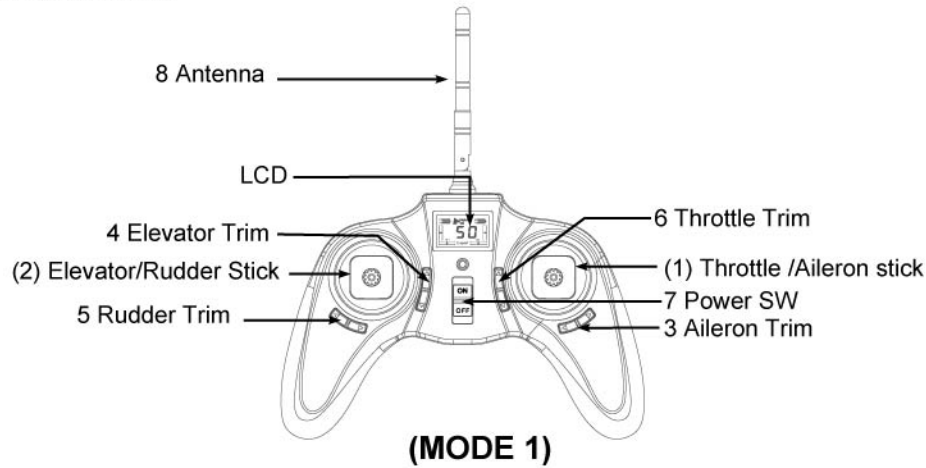

## 6.2 Effect of Control

**CAUTION:** To avoid loss of control: ALWAYS move the controls S-L-O-W-L-Y! Be aware that control inputs will reduce available lift (see 'Helicopter Principles of Flight'). Be ready to use a little extra Throttle to maintain height during maneuvers.

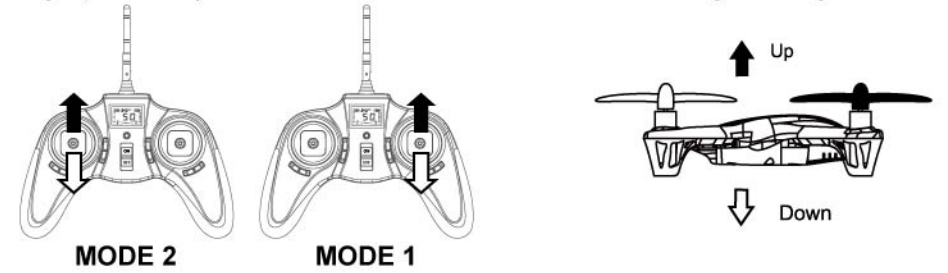

**Throttle (Collective Power) increases/decreases the Flying Height your quadcopter**

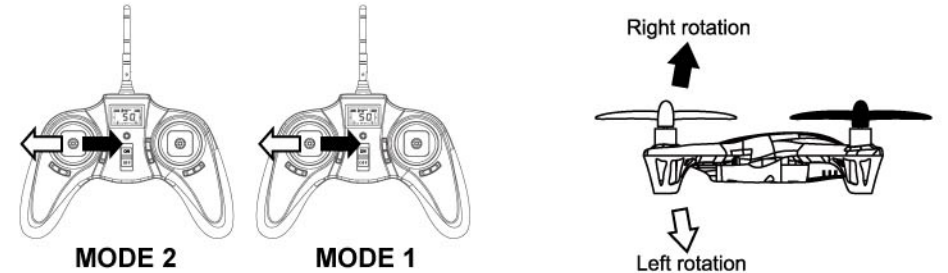

**Rudder (Collective Torque Yaw) rotates your quadcopter's fuselage Left / Right**

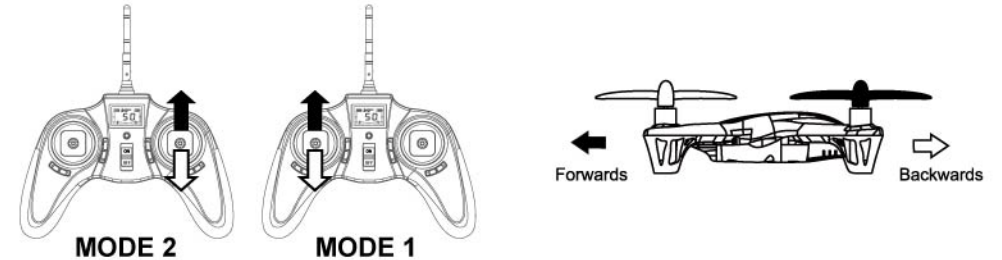

**Elevator (Cyclic Pitch) moves your quadcopter Forwards/Backwards**

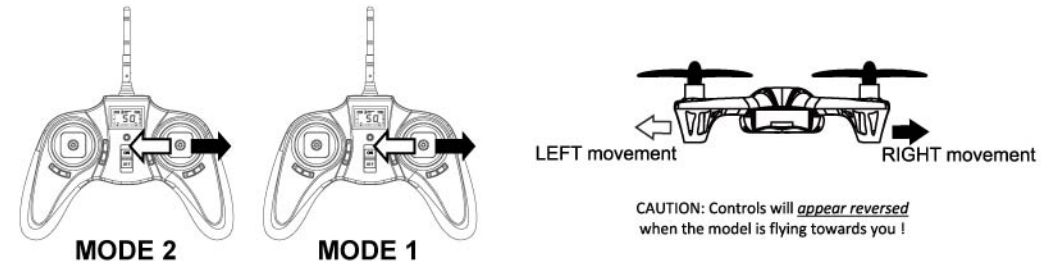

**Aileron (Cyclic Roll) moves your quadcopter 'sideways' Left/Right**

**CAUTION:** Controls will *appear reversed* when the model is flying towards you !



### 6.1.2 Power on the transmitter

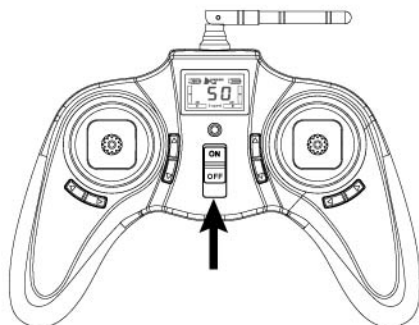

### 6.1.3 Switch on the quadcopter by connecting the battery cables with correct polarity

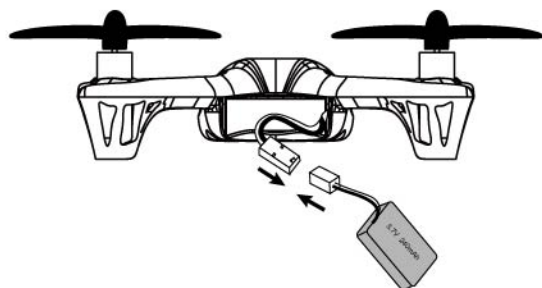

6.1.4 Insert the battery to the bottom of your quadcopter, make sure the battery need to be pushed to the end of the battery compartment.

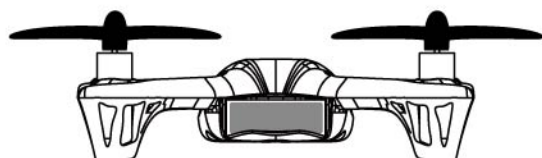

Tip: You no need to adjust the rudder trimming button if the quadcopter keep left turn or right turn during flight, The quadcopter will find the rudder central point automatically in 3 secondes after the quadcopter landing on a horizontal ground

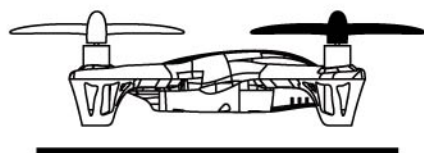

Landing on a horizontal ground

### Input Key Function

S/N	Identification	Function
1	Throttle/Rudder Stick	Forward and backward movement of the stick makes the quadcopter ascend and descend respectively. Left and right movement of the stick will rotate the quadcopter's fuselage left/right respectively.
2	Elevator/Aileron Stick	Forward and backward movement of the stick makes the quadcopter move forward and backward respectively. Left and right movement of the stick makes the quadcopter drift sideways left/right respectively.
(1)	Throttle /Aileron stick	Forward and backward movement of the stick will make the quadcopter increase or decrease speed respectively. Left and right movement of the stick makes the quadcopter roll left/right to initiate a turn.
(2)	Elevator/Rudder Stick	Forward and backward movement of the stick makes the quadcopter nose point up/down respectively. Left and right movement of the stick makes the quadcopter yaw left/right respectively.
3	Aileron Trim	Aileron trim subsidiary adjusts left and right drift.
4	Elevator Trim	Elevator trim subsidiary adjusts forward and backward movement.
5	Rudder Trim	Rudder trim subsidiary adjusts left and right rotation.
6	Throttle Trim	Throttle trim subsidiary adjusts ascent and descent.
7	Power SW	Pushing up switches on the power transmitter, pulling down switches it off.
8	Antenna	Transmits wireless signal

### 4.2 Reversing channel setup

#### 4.2.1.ELEV REVERSE SET UP

Hold down the Elevator/Aileron or ( mode 1 : Elevator/Rudder) stick for 1 second to enter the setting status, press Elevator Trim key up or down to choose reverse, and then hold down the Elevator/Aileron stick for 1 second to confirm and exit.

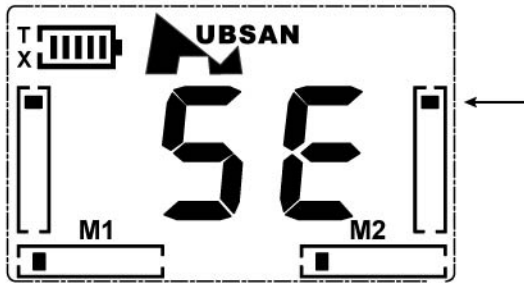

#### 4.2.2. AILE REVERSE SET UP

Hold down the Elevator/Aileron or (mode 1 : Elevator/Rudder) stick for 1 second to enter the setting status, press Aileron Trim key left or right to choose reverse, and then hold down the Elevator/Aileron or (mode 1 : Elevator/Rudder) stick for 1 second to confirm and exit.

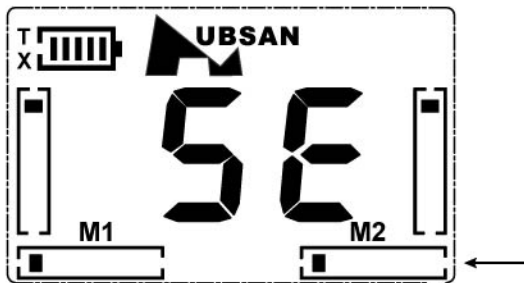

#### 4.2.3. RUDD REVERSE SET UP

Hold down the Elevator/Aileron or (mode 1 : Elevator/Rudder) stick for 1 second to enter the setting status, press Rudder Trim key left or right to choose reverse, and then hold down the Elevator/Aileron or (mode 1 : Elevator/Rudder) stick for 1 second to confirm and exit.

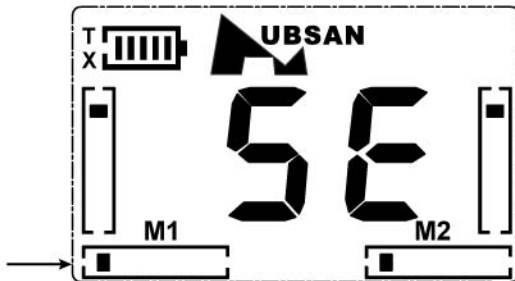

#### 5.2. Please refer to 2.2. Safety Advisory Notice

Always partially charge your LiPo battery before storage. LiPo batteries retain a charge over a reasonable period; It is not normally necessary to recharge stored LiPo batteries unless stored for periods longer than 3-6 months.

If your LiPo battery has been over-discharged, it will not be possible to recharge it again.



#### LiPo Battery Disposal & Re-Cycling



Lithium-Polymer (LiPo) batteries must not be placed in with household refuse. Please contact your Local Authority (Council) or the supplier of your model for local regulations and the location of your nearest LiPo battery recycling centre.

##### TEMPORARY STORAGE of DAMAGED LIPO BATTERIES:

Bury the LiPo battery in a bucket of dry sand or (if discharged) the battery may be neutralized by immersion in a salt water bath.  
If in doubt: always seek expert advice!

## 6. Start to fly

#### 6.1 Power-On (Failsafe) Procedure

Your RC quadcopter's 4-in-1 Gyro Receiver is fitted with a Power-On failsafe. This is designed to ensure that the quadcopter's motor will not start unless it detects a suitable radio-control signal when the LiPo battery is connected. The correct Start-Up sequence is as follows:

##### 6.1.1 Minimize the throttle to zero position

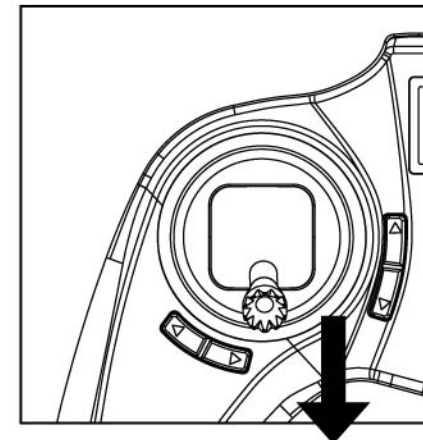



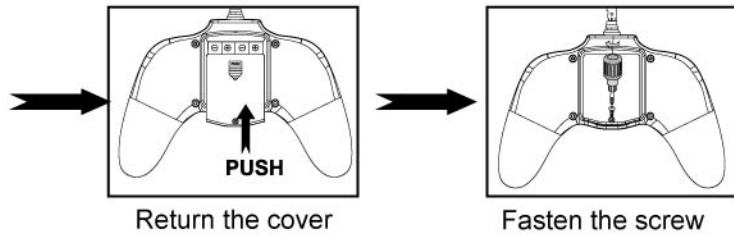

## 5 Li-Po Battery Charging

### 5.1 The quadcopter equipped with a 3.7V 240mAh Lipo battery

1. Take out the battery from bottom of the quadcopter.

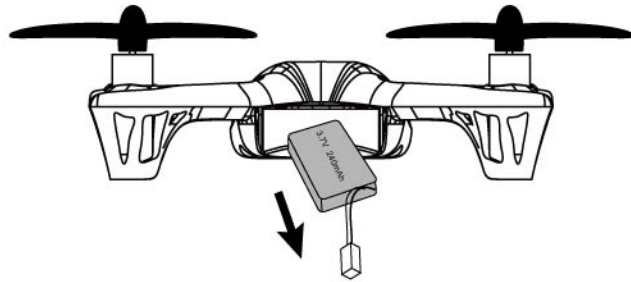

2. Connect the battery with USB charger, the LED light is ON whilst charging and turns OFF when charging complete.

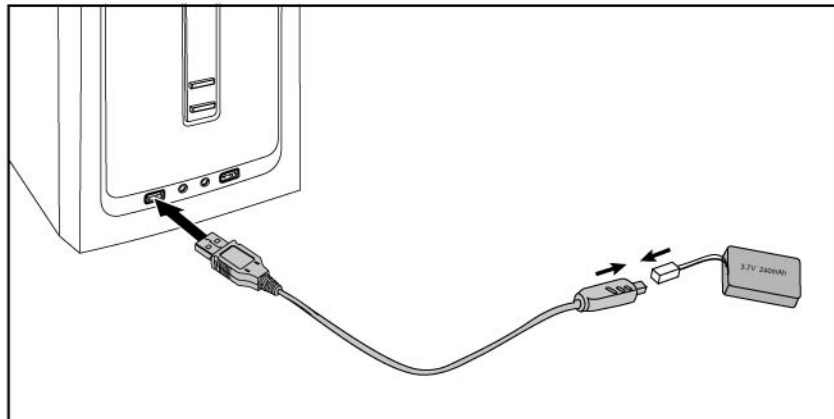

### 4.2.4. EXPERT MODE REVERSE SET UP

Hold down the Elevator/Aileron or (mode 1 : Elevator/Rudder) stick for 1 second to enter the setting status, press Throttle Trim key up or down to choose reverse, and then hold down the Elevator/Aileron or (mode 1 : Elevator/Rudder) stick for 1 second to confirm and exit.

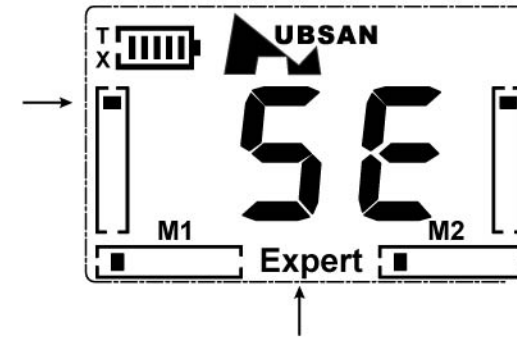

### 4.3 SENSITIVITY SET UP

#### 4.3.1 RUDDER SENSITIVITY SET UP- NOR MODE

Hold down the Elevator/Aileron or (mode 1 : Elevator/Rudder) stick for 1 second to enter the setting status, press Throttle/Rudder or (mode 1: Elevator/Rudder) key until the three-point dotted line symbol start to flash (see picture below), press Rudder Trim to idea sensitivity and then hold down the Elevator/Aileron or (mode 1 : Elevator/Rudder) stick for 1 second to confirm and exit.

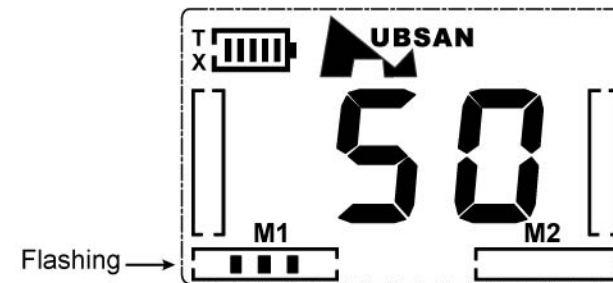

#### 4.3.2. ELEV SENSITIVITY SET UP- NOR MODE

Hold down the Elevator/Aileron or (mode 1 : Elevator/Rudder) stick for 1 second to enter the setting status, press Throttle/Rudder or (mode 1: Elevator/Rudder) key until the three-point dotted line symbol start to flash (see picture below), press Elevator Trim to idea sensitivity and then hold down the Elevator/Aileron or (mode 1 : Elevator/Rudder) stick for 1 second to confirm and exit.

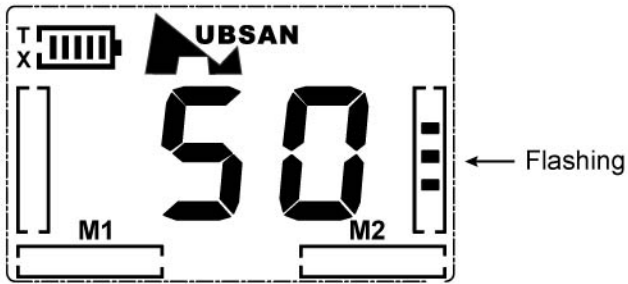

#### 4.3.3 AILE SENSIVITY SET UP- NOR MODE

Hold down the Elevator/Aileron or (mode 1 : Elevator/Rudder) stick for 1 second to enter the setting status,press Throttle/Rudder or(mode 1:Elevator/Rudder) key until the three-point dotted line symbol start to flash(see picture below),press Aileron Trim to idea sensitivity and then hold down the Elevator/Aileron or (mode 1 : Elevator/Rudder) stick for 1 second to confirm and exit.

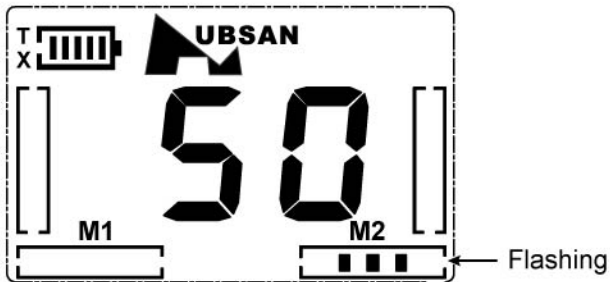

#### 4.3.4 RUDDER SENSIVITY SET UP- EXPERT MODE

Hold down the Elevator/Aileron or (mode 1 : Elevator/Rudder) stick for 1 second to enter the setting status,press Throttle/Rudder or(mode 1:Elevator/Rudder) key until the five-point dotted line symbol start to flash(see picture below),press Rudder Trim to idea sensitivity and then hold down the Elevator/Aileron or (mode 1 : Elevator/Rudder) stick for 1 second to confirm and exit.

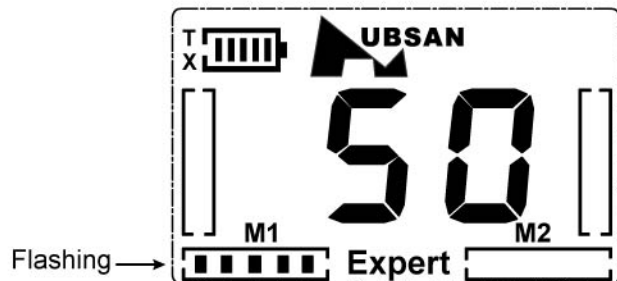

#### 4.3.5. ELEV SENSIVITY SET UP- EXPERT MODE

Hold down the Elevator/Aileron or (mode 1 : Elevator/Rudder) stick for 1 second to enter the setting status,press Throttle/Rudder or(mode 1:Elevator/Rudder) key until the five-point dotted line symbol start to flash(see picture below),press Elevator Trim to idea sensitivity and then hold down the Elevator/Aileron or (mode 1 : Elevator/Rudder) stick for 1 second to confirm and exit.

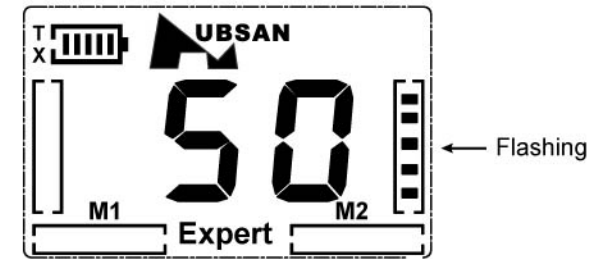

#### 4.3.6 AILE SENSIVITY SET UP- EXPERT MODE

Hold down the Elevator/Aileron or (mode 1 : Elevator/Rudder) stick for 1 second to enter the setting status,press Throttle/Rudder or(mode 1:Elevator/Rudder) key until the five-point dotted line symbol start to flash(see picture below),press Aileron Trim to idea sensitivity and then hold down the Elevator/Aileron or (mode 1 : Elevator/Rudder) stick for 1 second to confirm and exit.



#### 4.3 Battery Mounting

Notice:

- >Do not mix old and new batteries
- >Do not mix different types of batteries
- >Do not charge non-rechargeable battery.

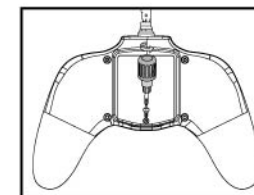

Release the screw

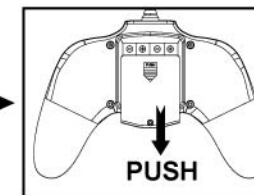

Take out the cover

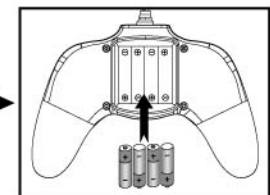

Install 4 x AAA battery according to the correct polarities